

Tools You will Need

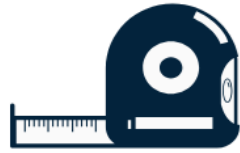

Power Drill

With a 1/8" drill bit (for pilot holes) and a Phillips head bit



Steel Tape Measure

* Cloth tapes are not accurate enough



Pencil or Pen

For marking bracket holes



Level

Crucial for ensuring the shade hangs straight



Screwdriver

Phillips and Flathead



Step Ladder

If your windows are tall



Drywall Anchors

If you are not drilling into wood studs

2 BRACKET INSTALLATION

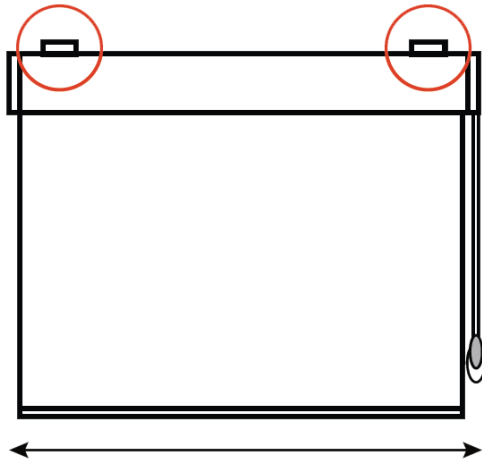

Up to 40 inches width Shades use 2 Brackets.

Shades 40" or narrower include 2 brackets. For optimal support, position brackets 4-5 inches from the side edges of the frame. This ensures the weight is evenly distributed across the Cassette.

3 BRACKET INSTALLATION

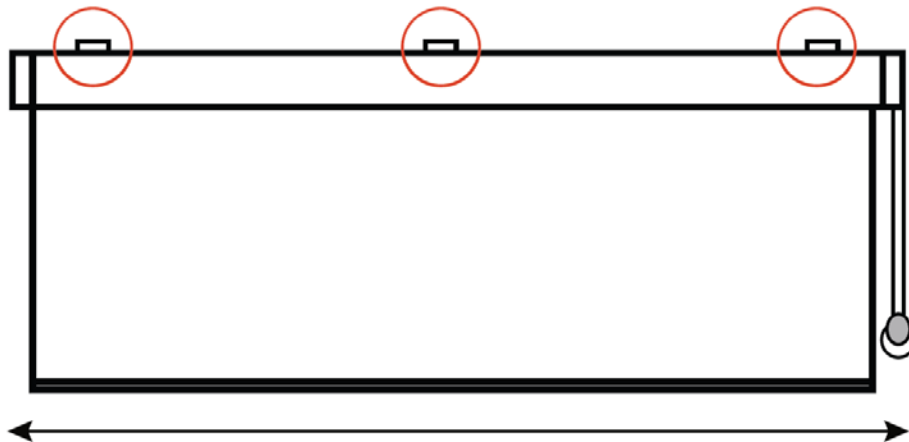

Shade widths over 40 inches use 3 Brackets

Shades 40" or longer include 3 brackets. For optimal support, position brackets 4-5 inches from the side edges of the frame and the third bracket in the center. This ensures the weight is evenly distributed across the Cassette.

Delta Artisan Shades installation Guide

- a. L Bracket with Mounting Bracket
- b. Screws
- c. Continuous Corded Loop Tensioner

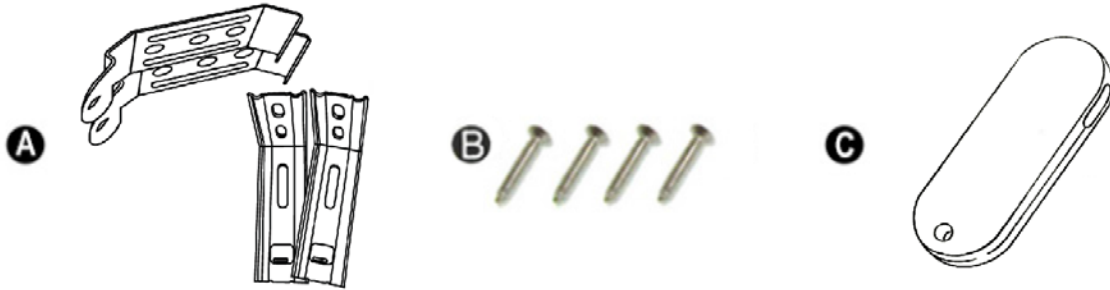

INSIDE MOUNT: For an inside mount installation you may only need to install the ceiling bracket. It will look like the following.

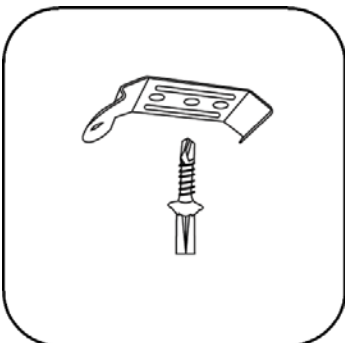

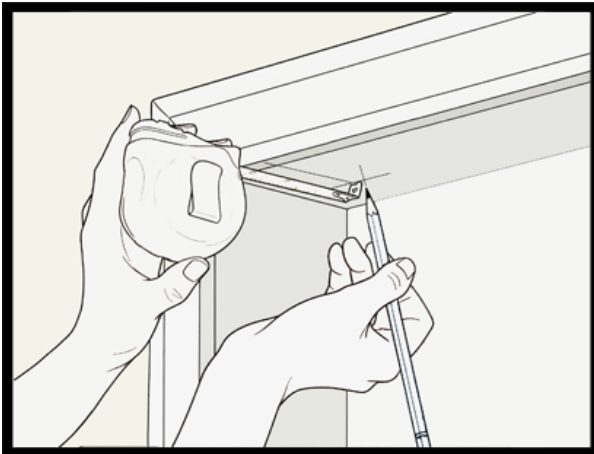

1. Before marking or drilling, dry-fit the brackets and cassette against the mounting surface.

This ensures perfect alignment and a smooth installation.

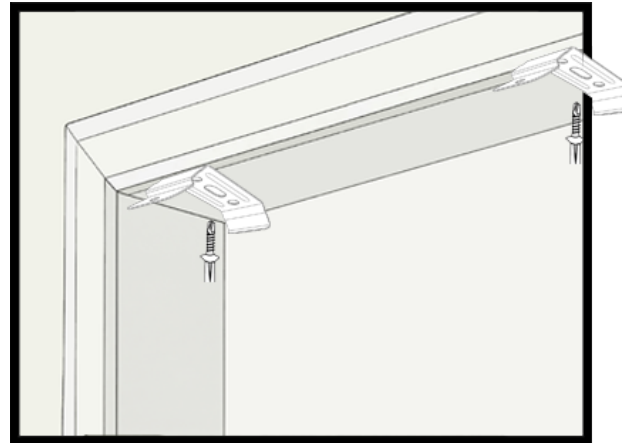

2. Secure the brackets by drilling directly into the top surface of the window frame casing.

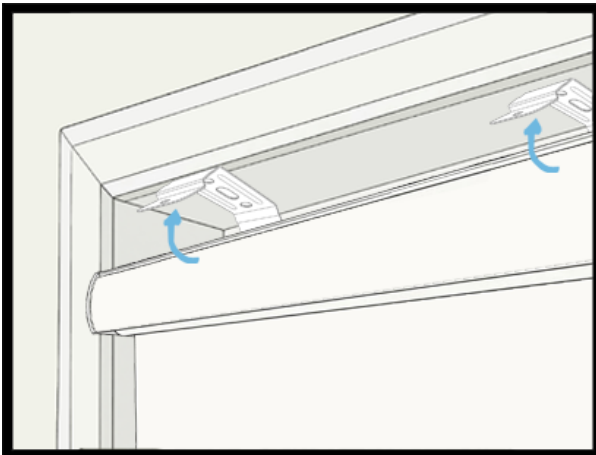

3. Hook the back edge of the cassette onto the brackets, then pivot the unit upward until it snaps securely into place.

Give the Cassette a gentle tug to verify it is fully locked.

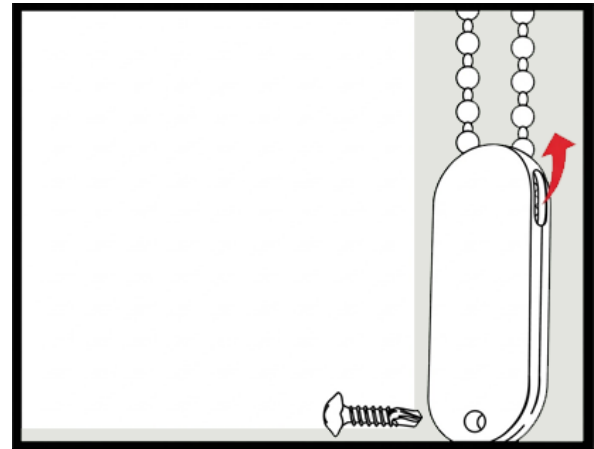

4. If you are installing a corded shade, it will include a cord tensioner. Secure the cord tensioner to the wall. The cord should be snug enough to eliminate loops and allow the shade to operate smoothly.

This installation is required to ensure proper mechanical function and to maintain strict child safety compliance.

Outside Mount: For an outside mount installation you will need to assemble and install the L Brackets and Mounting Brackets as follows.

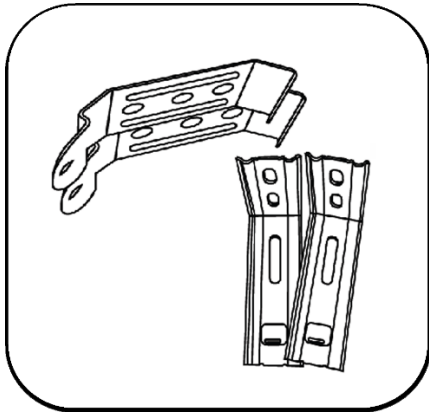

Ceiling/L Brackets. Figure Shows two you may receive more for each blind depending if it requires a third for longer shades.

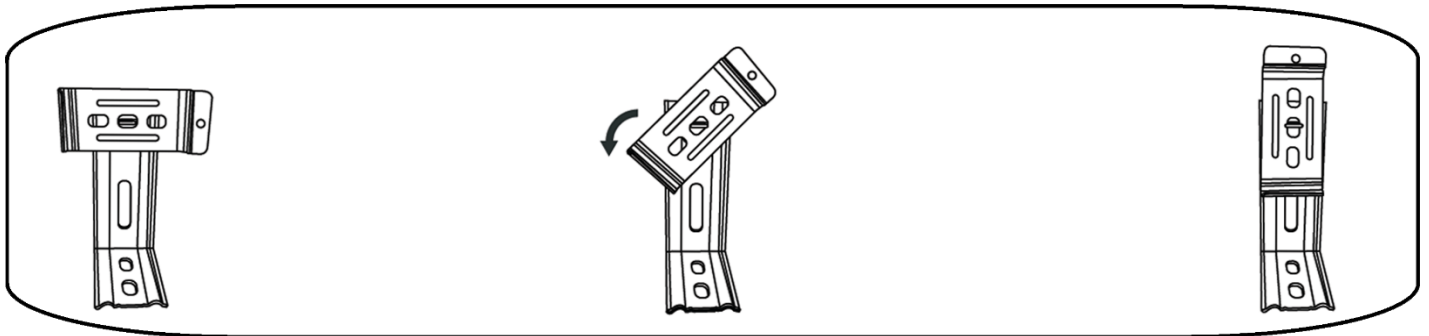

Take one of each of the brackets and twist and turn the ceiling bracket on to the L Bracket. Make sure to turn the release tab towards the front

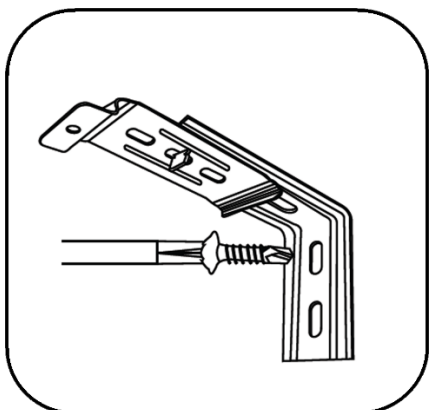

This assembled bracket allows the customer to mount the shades to the wall where the brackets cannot butt up against the upper frame.

Delta Artisan Installation Guide

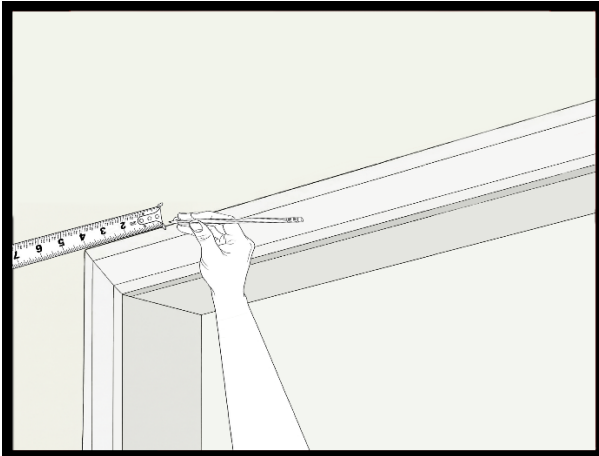

1. Before marking or drilling, dry-fit the brackets and cassette against the mounting surface.

This ensures perfect alignment and a smooth installation.

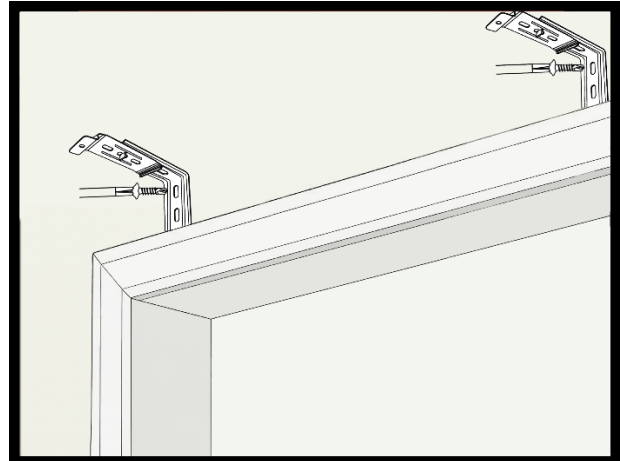

2. Secure the brackets by drilling directly into the wall surface. Ensure you are drilling into a solid surface or a wall stud for maximum stability.

If a stud is not available, you must use heavy-duty metal sheetrock anchors to prevent the brackets from pulling loose.

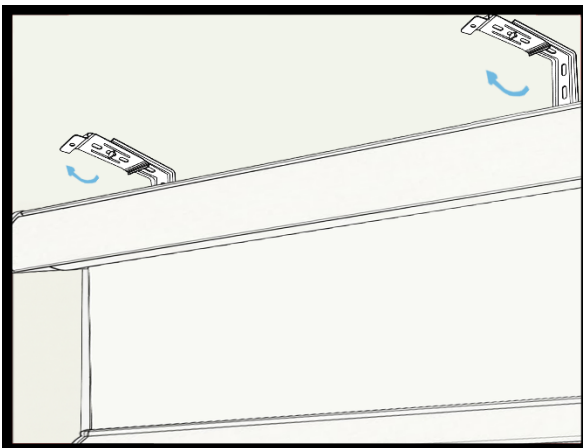

3. Hook the back edge of the cassette onto the brackets, then pivot the unit upward until it snaps securely into place.

Give the headrail a gentle tug to verify it is fully locked.

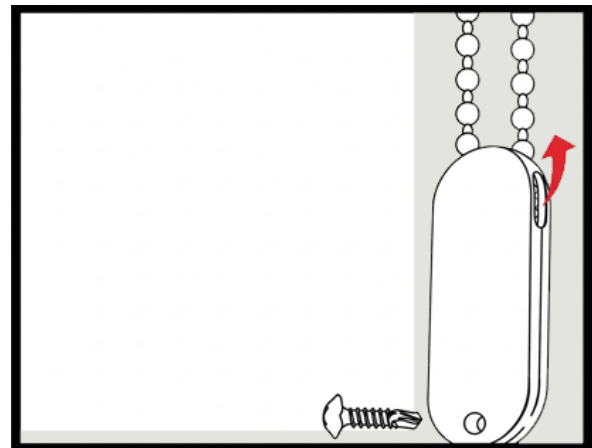

4. If you are installing a corded shade, it will include a cord tensioner. Secure the cord tensioner to the wall. The cord should be snug enough to eliminate loops and allow the shade to operate smoothly.

This installation is required to ensure proper mechanical function and to maintain strict child safety compliance.